

NORDIK® EVOLUTION RANGE

Ideal for use in bedrooms, living rooms, shops, stores and other public places.

- Nominal diameter of blades 900, 1200, 1400 and 1600 mm.
- Top and bottom motor covers moulded from heat-resistant and UV-resistant thermoplastic resin (ABS), colour white.
- Wiring connections at end of ceiling rod concealed by domes moulded from impact- and UV-resistant thermoplastic resin (PP).
- Four color finishes: white, silver, black and briar wood.
- Single phase start capacitor motor with external rotor, and shaft turning in ball bearings. Direction of rotation reversible.
- Maximum air flow 17011 m³/h.
- 3 sheet steel blades powder coated with scratch-resistant polyester.
- Steel ceiling rod with scratch-resistant polyester powder coated finish, length 375 mm.
- Bag of accessories containing nuts and bolts required for assembly of blades, ceiling hook and rubber anti-vibration washer.
- Factory-prepared to accept 2 specific optional light kits: with lamp rated 105 W max, E27 screw fitting; with 2x15 W max energy saving lamp, E27 screw fitting (mandatory in EU).
- Speed selectable by way of control units or Telenordik 5TR remote control (optional).
- Insulation class: Cl.I Ⓢ.

Reverse function

It allows to reverse the air flow direction from floor to ceiling: this means that the flow is no longer direct, but wider and more all-round. It also help reducing the difference in temperature between the floor (where the temperature is lower) and the ceiling (where it is in winter time).



EVOLUTION LIGHT KIT ES
with 1 incandescent light with max
power 105 W and E27 socket.

EVOLUTION LIGHT KIT
with 2 energy efficient E27
socket lamps.



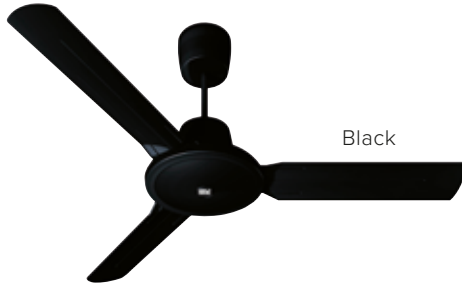
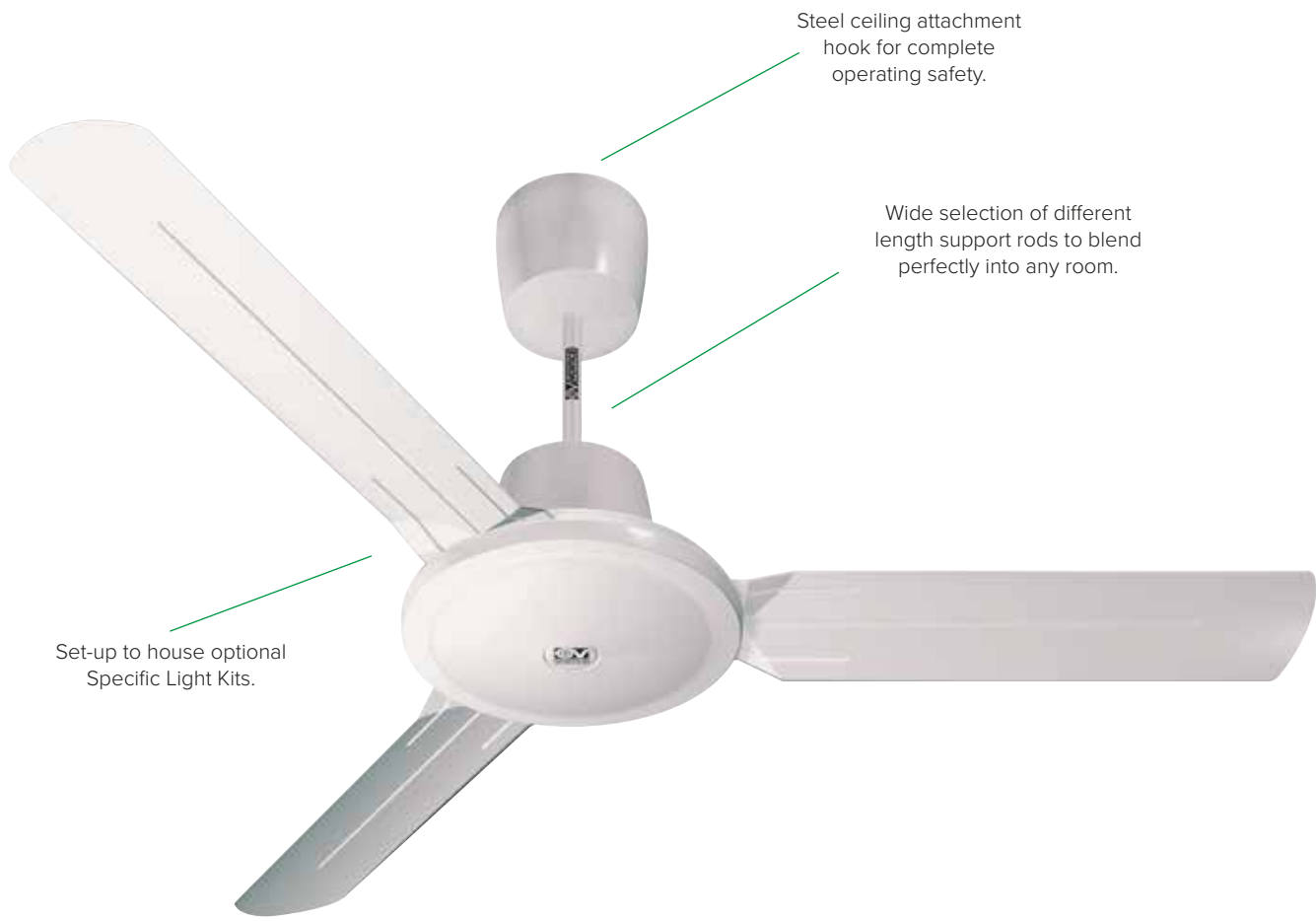

Nordik Evolution Gold models differ from the other models of the Range for their fine aesthetics, the result of advanced technologies that give the products the characteristic metallic mirror finish in white gold color.

NORDIK EVOLUTION RANGE
REVERSIBLE CEILING FANS

TECHNICAL DATA

MODELS	CODE	COLOR	V	HZ	W	A	RPM	NR. BLADE	MAX AIRFLOW m ³ /h	Kg
NORDIK EVOLUTION R 90/36"	61750	WHITE	220 - 240	50	70	0.34	200	3	11592	6.4
	61751	WHITE	220 - 240	50	70	0.34	198	3	13810	6.8
	61754	SILVER	220 - 240	50	70	0.34	198	3	13810	6.8
NORDIK EVOLUTION R 120/48"	61755	WOOD GRAIN	220 - 240	50	70	0.34	198	3	13810	6.8
	61756	BLACK	220 - 240	50	70	0.34	198	3	13810	6.8
	61733	WHITE GOLD	220 - 240	50	70	0.34	198	3	13810	6.8
NORDIK EVOLUTION R 140/56"	61752	WHITE	220 - 240	50	70	0.35	197	3	16586	7.1
	61757	SILVER	220 - 240	50	70	0.35	197	3	16586	7.1
	61758	WOOD GRAIN	220 - 240	50	70	0.35	197	3	16586	7.1
NORDIK EVOLUTION R 140/56"	61759	BLACK	220 - 240	50	70	0.35	197	3	16586	7.1
	61734	WHITE GOLD	220 - 240	50	70	0.35	197	3	16586	7.1
NORDIK EVOLUTION R 160/60"	61753	WHITE	220 - 240	50	70	0.34	193	3	17011	7.6

NORDIK® EVOLUTION RANGE | TECHNICAL DATA FOR REGULATION N° 206/2012 UE

	SYMBOL	UNIT OF MEASURE	NORDIK EVOLUTION 90/36"	NORDIK EVOLUTION 120/48"	NORDIK EVOLUTION 140/56"	NORDIK EVOLUTION 160/60"
CODE			61750	61751 - 61754 - 61755 - 61756 - 61733	61752 - 61757 - 61758 - 61759 - 61734	61753
Maximun fan air flow	F	m ³ /min	193.20	230.17	276.43	283.52
Fanpower input	P	W	70	70	70	70
Service value	SV	(m ³ /min)W	2.760	3.288	3.949	4.050
Standby power consumption	PSB	kW	-	-	-	-
Fan sound power level	LWA	dB(A)	46.1	49.1	52.6	55.6
Maximum air velocity	C	m/sec	3.52	2.36	2.08	1.63

Measurement standard for service value

IEC 60879; EN62301: UNI EN ISO 3741

For more information refer to: Vortice Elettrosociali Spa, Strada Cerca, 2 - 20067 Zoate di Tribiano (MI) Italia

DIMENSIONS

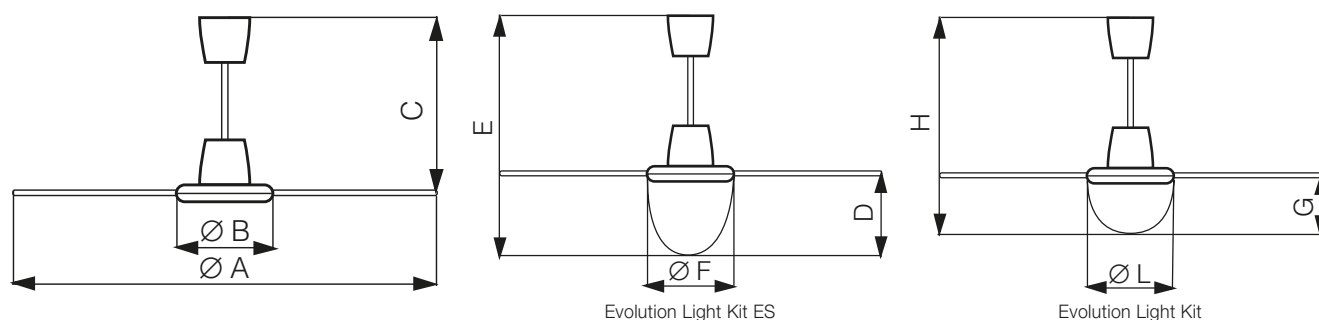

MODELS	CODE	ØA	ØB	C	ØD	E	ØF	G	H	ØL
NORDIK EVOLUTION R 90/36"	61750	980	298	495	229	724	291	145	640	291
NORDIK EVOLUTION R 120/48"	61751 - 61754 - 61755 - 61756 - 61733	1284	298	495	229	724	291	145	640	291
NORDIK EVOLUTION R 140/56"	61752 - 61757 - 61758 - 61759 - 61734	1488	298	495	229	724	291	145	640	291
NORDIK EVOLUTION R 160/60"	61753	1590	298	495	229	724	291	145	640	291

Dimensions (mm)



NORDIK EVOLUTION RANGE

REVERSIBLE CEILING FANS

ACCESSORIES

TELENORDIK 5TR (code 22386)



- New infrared remote control 5 speeds-timer-reverse
- The receiver is hidden inside the fan casing, with only the tip in which the sensor is located protruding.
- Uses infrared transmission to eliminate possible interference with radios or other electrical units.
- Set consists of a receiver, which is fitted to the fan ceiling rod, a transmitter, which sends the desired commands to the fan and a transmitter carrying case which can be fixed to the wall.
- Provided with LED indicators showing operation and "stand-by" status (power on).
- Remote-control range: approximately 13 meters line of sight.
- Fan and remote-control unit are both IMQ approved.
- Easy to install as connections between the fan and fixed speed regulator are not necessary.
- Transmitter can control any TeleNordik receiver.

Remote control	-	infrared
Receiver Volt at 50 Hz	Hz	220-240
Stand by	W	0.558
Maximum load Watt	W	100
Transmitter battery	-	2 x AAA 1.5 V
Receiver	Kg	0.76
Transmitter	Kg	0.06
Insulation	-	Cl. II

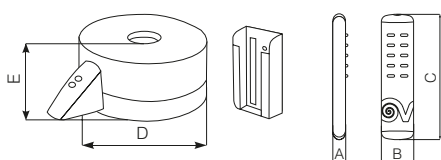

Models	A	B	C	D	E
5TR	20	43	155	154	62

Dimensions (mm)

EVOLUTION LIGHT KIT ES (code 22414)

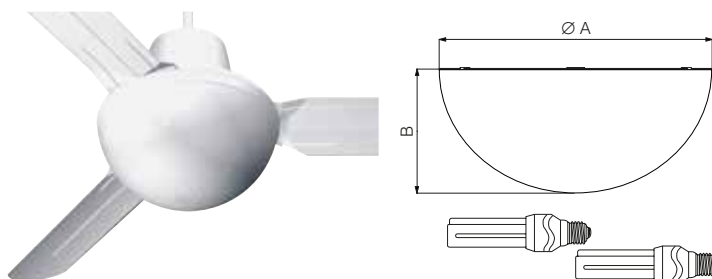

- Lighting system kit for all Nordik Evolution fans.
- Model for two energy saving lamps with Edison E27 fittings and maximum power output of 15 W each (equivalent to 75 W each).
- Diffuser globe made of strong laminated glass with opaque finish.
- Lamp max 15 W.
- Length=165 mm max.
- Not suitable for incandescent bulbs.

Models	ØA	B	Kg
Evolution Light Kit ES	291	120	1.0

EVOLUTION LIGHT KIT (code 22413)

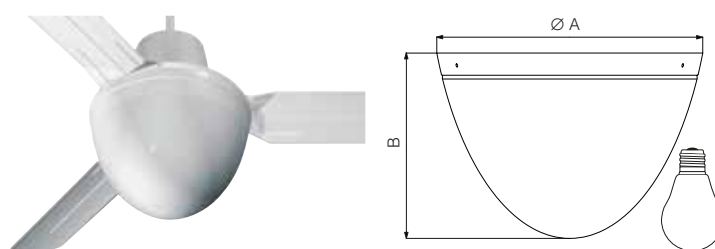

- Lighting system kit for all Nordik Evolution fans.
- Model for one traditional incandescent bulb with Edison E27 fitting and maximum power output of 150 W.
- Diffuser made of opalescent laminated glass.

Models	ØA	B	Kg
Evolution Light Kit	291	203	1.6

KIT SCBRR5/5L/M BUILT-IN (cod. 22489)



- Kit to convert SCRR5 and SCRR5L position controllers from surface to flush-mounted.

SCRR/M (code 12965)



- Electronic reversible speed controller for use with up to 6 ceiling-mounted fans.
- Convertible to flush mounted using SCBRR5/5L/M.
- 220-240V ~ 50 Hz.
- Maximum load: 450W (2.5 A).
- Weight: 0.2 Kg.
- Double insulation.

SCRR5 (code 12963)



- 5-position reversible speed controller for ceiling-mounted fans without light.
- Convertible to flush-mounted using SCBRR5/5L/M.
- 220-240V ~ 50 Hz.
- Maximum load: 100W.
- Weight: 0.58 Kg.
- Double insulation.

SCRR5L (code 12964)



- 5-position reversible speed controller for ceiling-mounted fans with light.
- Convertible to flush-mounted using SCBRR5/5L/M.
- 220-240V ~ 50 Hz.
- Maximum load: 250W.
- Weight: 0.58 Kg.
- Double insulation.

ACCESSORIES

FLUSH OR WALL MOUNTED CONTROLS

SC 503 B (cod. 12801)



SC 503 N (cod. 12802)



SC EXT B (cod. 12803)



Thanks to their simple innovative design, these units more than meet the aesthetics expected of them for both domestic and commercial applications. Backing plate, knob, sliders and adapters made from polycarbonate; face plate and controller for wall mounting made from UV-resistant ABS. On the white and anthracite grey flush mounted versions, the knob and face plate are in matching colours. Both the flush and wall mounted version come with:

- knob with settings from 0 to 5 for various speeds (0 = OFF, 1- 5 = fan speed);
- a LED that shows when the fan is ON.
- two slider switches - one for the light and the other to reverse the fan (where applicable).
- Vortice ceiling fan controls are IMQ approved solely and exclusively for use with Vortice ceiling fans.

AVAILABLE OPTIONAL ANCILLARIES



Anthracite grey face plate
code 22463



White face plate
code 22462

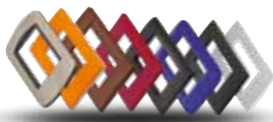

Recessed versions, thanks to an intermediate adjustable support, can be coupled with various existing standard face plates, satisfying diverse aesthetic requirements.

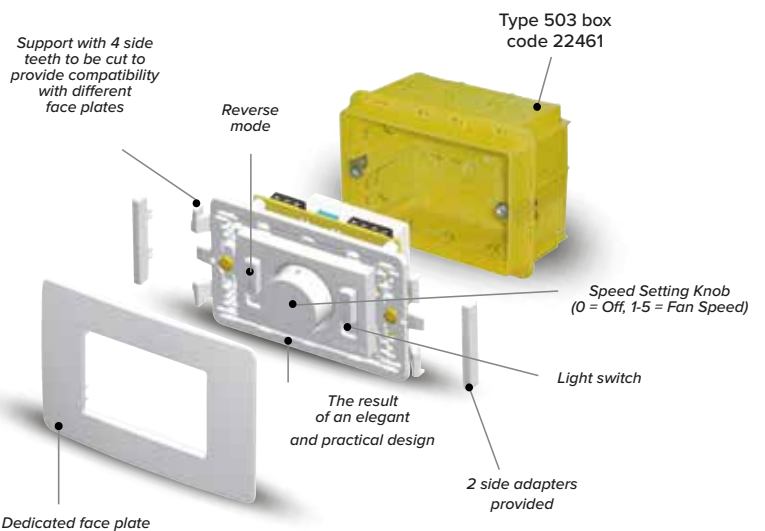

Power supply voltage (V): 220 - 240
Power supply frequency (Hz): 50
Max power consumption (W): 18

NORDIK EVOLUTION RANGE
REVERSIBLE CEILING FANS

ACCESSORIES

MULTIPLE SPEED CONTROLLER



VORT DELTA T (Code 13039)
MULTIPLE SPEED CONTROLLER UP TO 16 CEILING FANS

The intelligent control system. Simply clever: Intelligent management ensures optimal, draughtfree operation Vort Delta T - the heart of the System.

- The new, intelligent control unit Vort Delta T is equipped with two semiconductor temperature sensors (included in the package), installed respectively at ceiling and floor level.
- Electrical power is with a normal two-phase cable, of up to 50 metres in length.
- The control unit registers the temperature at ceiling and floor level up to 60 times per minute, calculates the temperature differential and in accordance with this, regulates the operating speed of the fans. When the heat layer has been dissipated and the temperature differential has been reduced to an acceptable level, the Vort Delta T automatically switches the fans off.
- The minimal temperature differential, at which level the unit is activated, is adjustable, as are the lower and higher rotational fan speeds so as to avoid draughts. This also applies to permanent operation (e.g. during summer for cooling).
- This fully automatic control system governs the system optimally, without necessitating adjustment by the users. In this manner, unauthorised meddling with the system is impossible.

- 1 The commercial building has a warm air heating system.
- 2 With the aid of adjustable laminar blades, the warm air is directed downwards in the recreation or working area.
- 3 Due to the fact that warm air has a lower specific weight than cold air, the warm air rises to ceiling height and accumulates there. The sensor controls registers the increasing temperature difference between the floor and ceiling. The Nordik fans are controlled so that the warm air from the ceiling is conducted back into the recreating or working area without causing a draught. As soon as the temperature difference between the ground and ceiling areas is in equilibrium, the Vort Delta T system automatically switches the fans off.

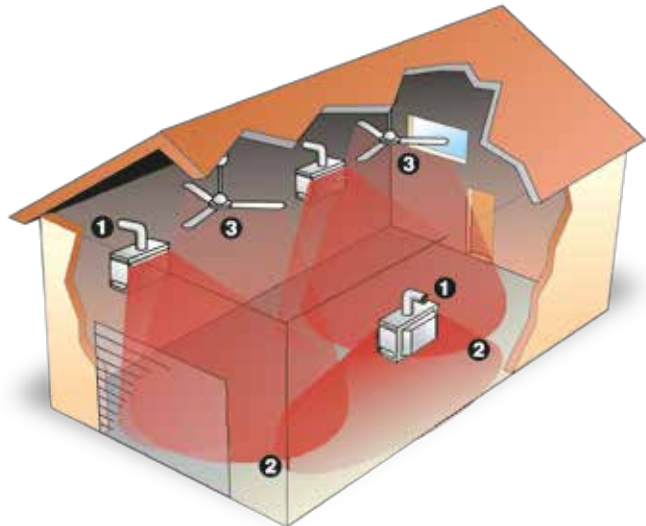

CEILING RODS

Various lengths to enable installation at desired height.



WHITE

- Asta NK | 200 mm (code 22032)
- Asta NK | 250 mm (code 22033)
- Asta NK | 350 mm (code 22042)
- Asta NK | 500 mm (code 22051)
- Asta NK | 750 mm (code 22074)
- Asta NK | 1000 mm (code 22077)



SILVER

- Asta NK | 200 mm (code 22023)
- Asta NK | 250 mm (code 22024)
- Asta NK | 350 mm (code 22026)
- Asta NK | 500 mm (code 22027)
- Asta NK | 750 mm (code 22028)
- Asta NK | 1000 mm (code 22029)



BLACK

- Asta NK | 275 mm (code 22036)
- Asta NK | 375 mm (code 22037)
- Asta NK | 520 mm (code 22038)
- Asta NK | 775 mm (code 22039)
- Asta NK | 1025 mm (code 22043)



WOOD-GRAIN

- Asta NK | 200 mm (code 22079)
- Asta NK | 275 mm (code 22047)
- Asta NK | 350 mm (code 22058)
- Asta NK | 500 mm (code 22092)
- Asta NK | 750 mm (code 22064)
- Asta NK | 1000 mm (code 22071)



WHITE GOLD

- Asta NK | 200 mm (code 22681)
- Asta NK | 250 mm (code 22682)
- Asta NK | 350 mm (code 22683)
- Asta NK | 500 mm (code 22684)
- Asta NK | 750 mm (code 22685)
- Asta NK | 1000 mm (code 22686)